

FORESEE®
Garage Door Opener

CE RoHS

ASSEMBLING AND OPERATING MANUAL
FOR FORESEE GARAGE DOOR OPENERS



F-330

PLEASE READ THIS MANUAL CAREFULLY BEFORE ASSEMBLING AND OPERATING















Contents

A. Inventory	2
B. Function Introduction	4
C. Assembly Procedure	5
D. The Appearance of the Main Body and the Transmitter	9
E. Wiring Diagram for Infrared Beam	10
F. Programming	11
G. Code and Decode	18
H. Technical Specifications	19
I. End User 's Guide	20
J. Assembly of the Rail in 2 Parts	22

A. Inventory

The garage door opener unit is packaged in two cartons which contain the opener pack and the rail assembly pack illustrated below.

Opener Pack

Appearance	Name	QTY
	Opener	1
	Manual	1
	Transmitter	2
	Curved Door Arm	1
	Support Bracket	2
	Bracket	3
	Header Bracket	1
	Door Bracket	1
Plum Offset Ring  (1x)	6x15 Hexagon Head Driving Screw  (8x)	
6x80 Screw with Hexagon Nut  (1x)	8x20 Insert Pin  (1x)	
2x20 Cotter Pin  (1x)	8x20 Screw with Hexagon Nut  (4x)	
Rail assembly pack (1x)		



WARNING

IMPORTANT SAFETY INSTRUCTIONS

**WARNING-IT IS VITAL FOR THE SAFETY OF PERSON TO
FOLLOW ALL INSTRUCTIONS
SAVE THESE INSTRUCTIONS**

- ◇ Do not allow children to play with controls;
- ◇ Keep remote controls away from children;
- ◇ Watch the moving door and keep people away until the door is completely open or closed;
- ◇ Frequently examine the installation, in particular cables, springs and mountings, for signs of wear, damage or imbalance. Do not use if repair or adjustment is needed since a fault in the installation or an incorrectly balanced door may cause injury.

B. Function Introduction

Intelligent Microcomputer	—	Intelligent computerized precise travel positioning; timely force detection, reversion occurs when obstacles are met.
Motor	—	Low noise, soft start, slow stop protect the motor and ensure a long service time.
Self Diagnosis	—	Operational mode and digital menu shown on the display, self diagnosis. (L-Normal, F-Interrupted, H-Fail In Reading, A-Infrared Ray Interrupted)
Cryptoguard	—	Rolling code technology provides billions of code combinations and makes every remote control a unique one that protects against unauthorized access.
Alarm Device	—	The alarm will sound if the door is left open for over 10 minutes. The alarm stops when the door is closed again. (Refer to F-7 on P.14)
Emergency Release	—	The door can be manually operated by pulling down on the emergency release rope in case of power failure. (Refer to C 4 on P.8)
Additional Safty Device	—	Safety further ensured with additional accessory photocells. (Refer to E on P.10).
Automatic closing door	—	The automatic closing time of the door can be set from 30 seconds to 240 seconds. (Refer to F-8 on P.14)
2000 cycles alarm	—	When the operator has run 2000 cycles, it will beep to remind the user to maintain the mechanical system. (Refer to F-9 on P.16)

C.Assembly Procedure



IMPORTANT SAFETY INSTRUCTIONS FOR INSTALLATION

WARNING-INCORRECT INSTALLATION CAN LEAD TO SEVERE INJURY

FOLLOW ALL INSTALLATION INSTRUCTIONS

- ◇ Before installing the drive, remove all unnecessary ropes or packing and disable any equipment which is not needed after installation of the drive;
- ◇ Before installing the drive, check that the door is in good mechanical condition and correctly balanced, and that it opens and closes properly;
- ◇ Install the actuating member for the manual release at height less than 1.8m;
- ◇ Install any fixed control within sight of the door but away from moving parts and at a height of at least 1.5m;
- ◇ Permanently fix the labels warning against entrapment in a prominent place or near any fixed controls;
- ◇ Permanently fix the label concerning the manual release adjacent to its actuating member;
- ◇ After installation, ensure that the mechanism is properly adjusted and that the drive reverses when the door contacts a 40mm high object placed on the floor;
- ◇ After installation, ensure that the parts of the door do not extend over public footpaths or roads; after installation, ensure that the drive prevents or stops the opening movement when the door is laded with a mass of 20kg, fixed centrally on the bottom edge of the door (for drives that can be used with doors having openings larger than 50mm in diameter)
- ◇ Install the drive at height no less than 2.5m.

C-1 Essential Tools

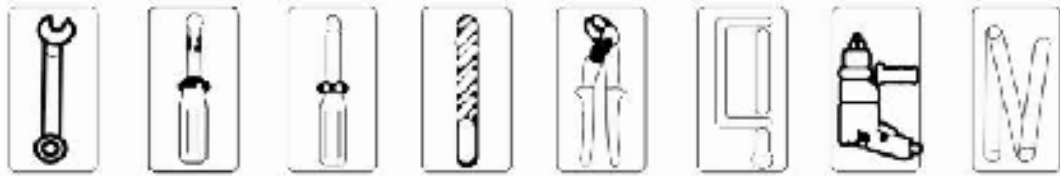

C-1 Connecting the Body with the Rail

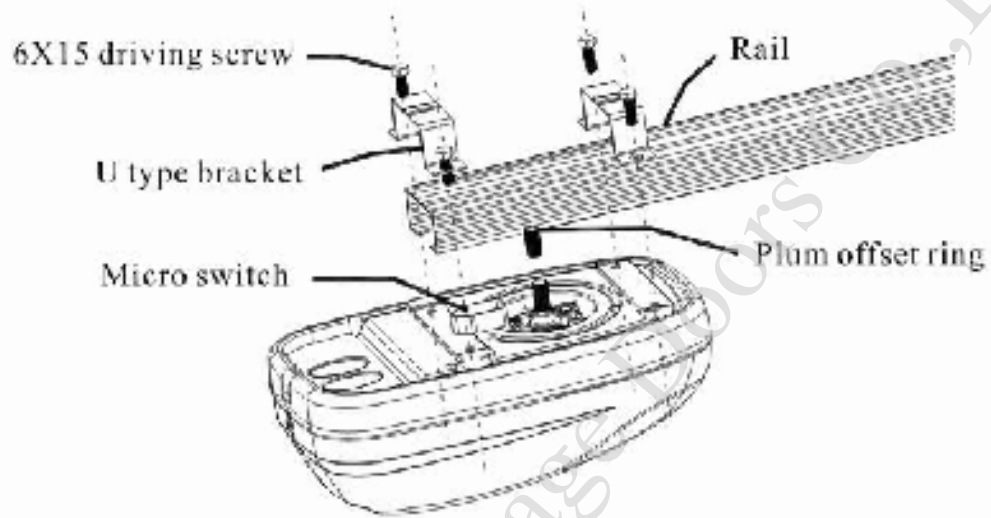

C-3 How to Fix the Body and the Rail

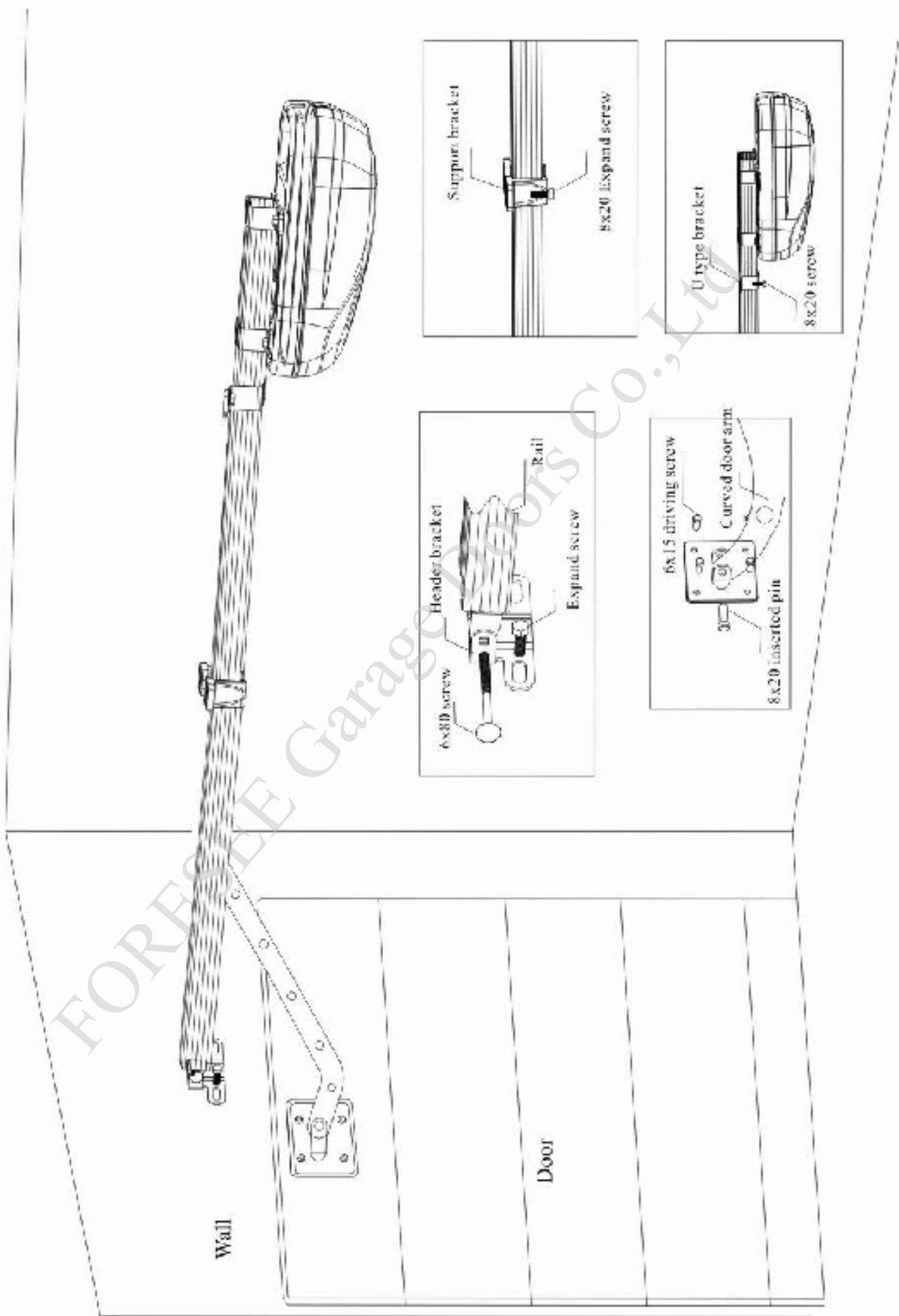

C-4 How to Operate the Door Manually

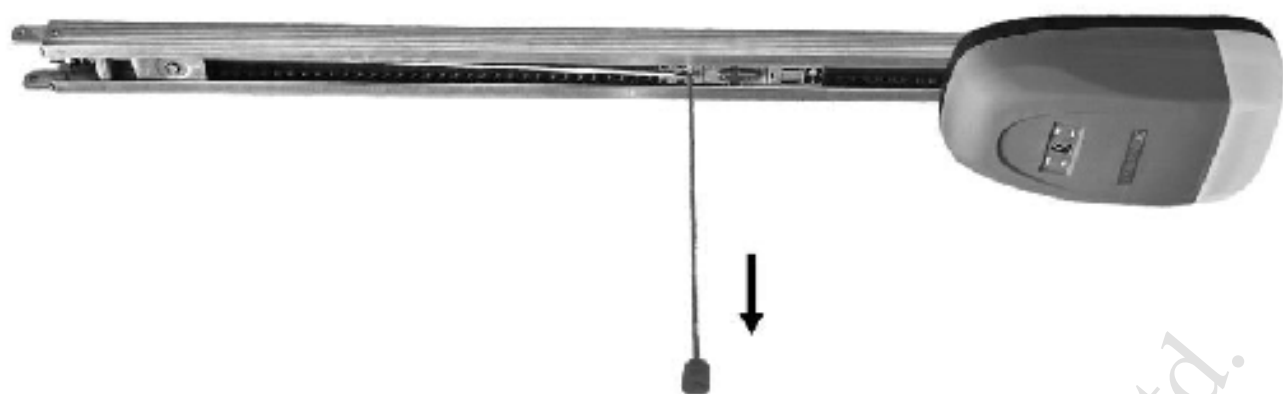

In the case of power failure-

(1) When the door is in the closed position:

Pull down on the rope and dis-engage the clutch, this will allow the door to be lifted with ease.

(2) When the door is in the open position:

Pull down on the rope once, this will allow the door to be moved downward to the closed position.

(If there's self-lock hole in the rail, the door can now be locked automatically.)

If power recovers-

Operate the handheld transmitter or the wall control again, the clutch will be re-engaged automatically.

D. The Appearance of the Main Body and the Transmitter

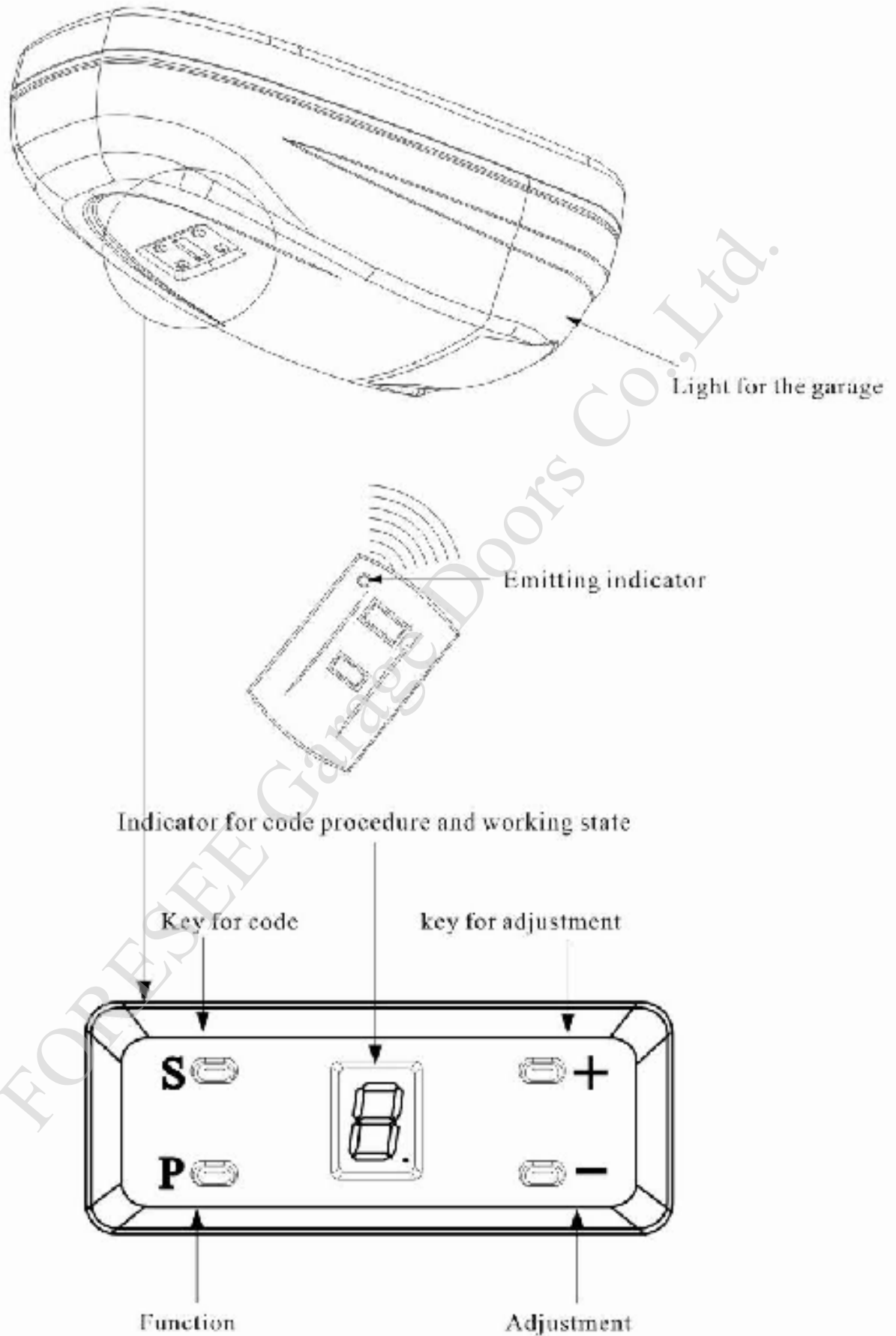

E. Wiring Diagram for Infrared Beam

a. Connect as follows

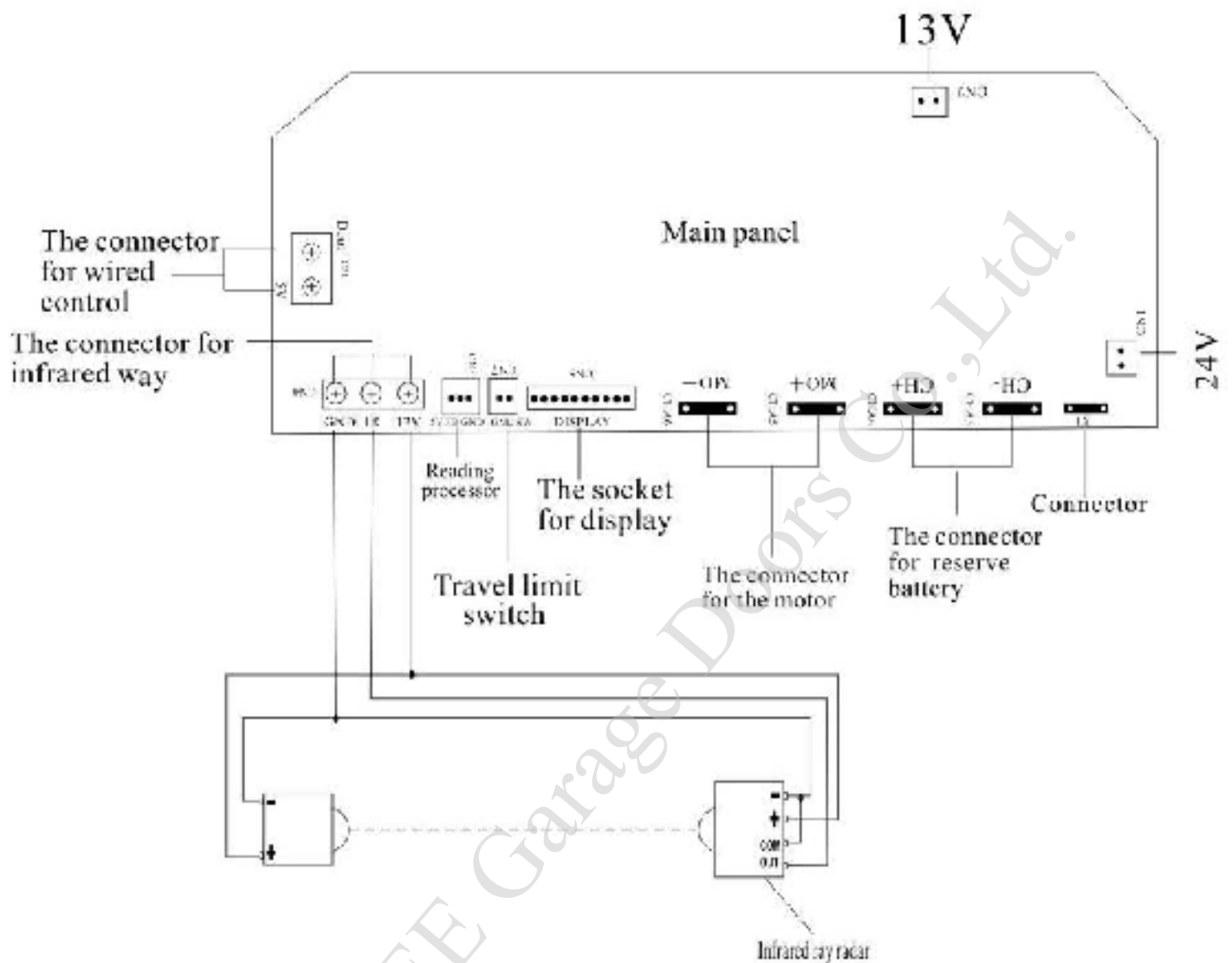

Wiring diagram

b. Ideal condition

Detecting way	Max distance	Volt	Current	Output way
Emitting and receiving	12m	12-24V	150 mA	NO / NC

F. Programming

- F-1 Prepare** — a. Gently move the door to engage the trolley so that the opener can drive the door
- b. Turn on the power, the light will come on, the unit will 'beep' once and the display shows "0" in cycles.

⚠ (If the finalize programming is not carried out, the setting will be deleted automatically. If wrong information has been programmed, you can turn the power off and then turn it on again to reset referring to the following.)

F-2 Up Limit Setting

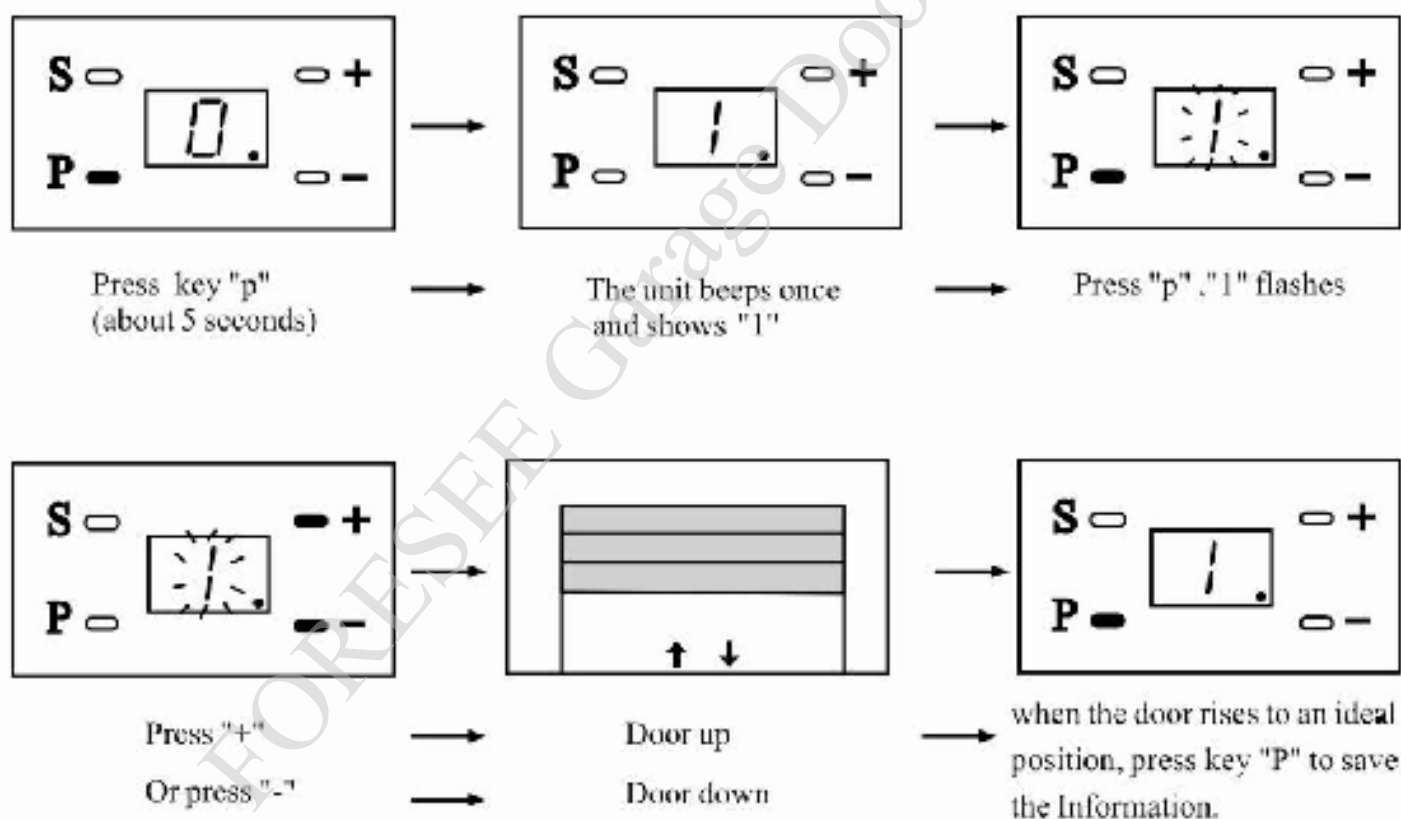

⚠ (NB: The saved information has no effect if this performance is used for down limit setting)

⚠ The up limit setting must be programmed before the down limit setting

F-3 Down Limit Setting

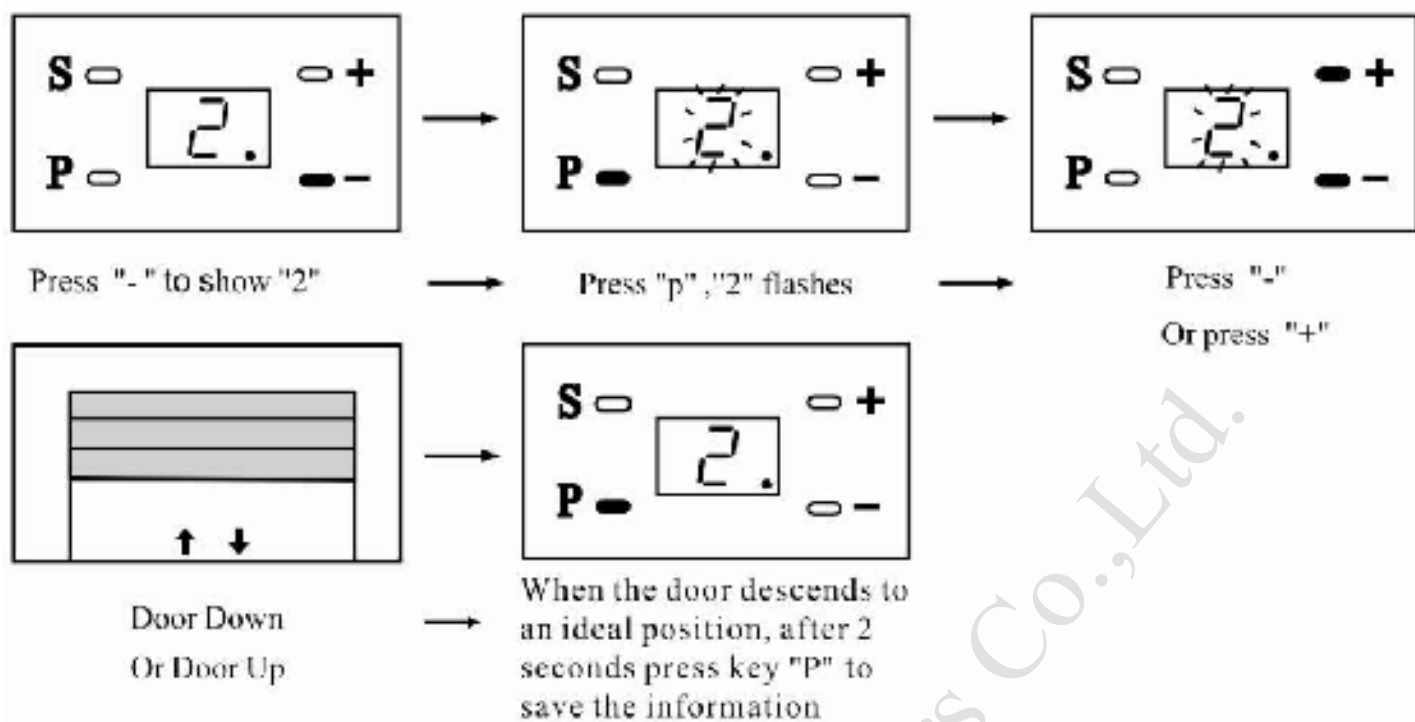

⚠ (NB: The saved information has no effect if this performance is used for up limit setting)

F-4 Operating Force Learning

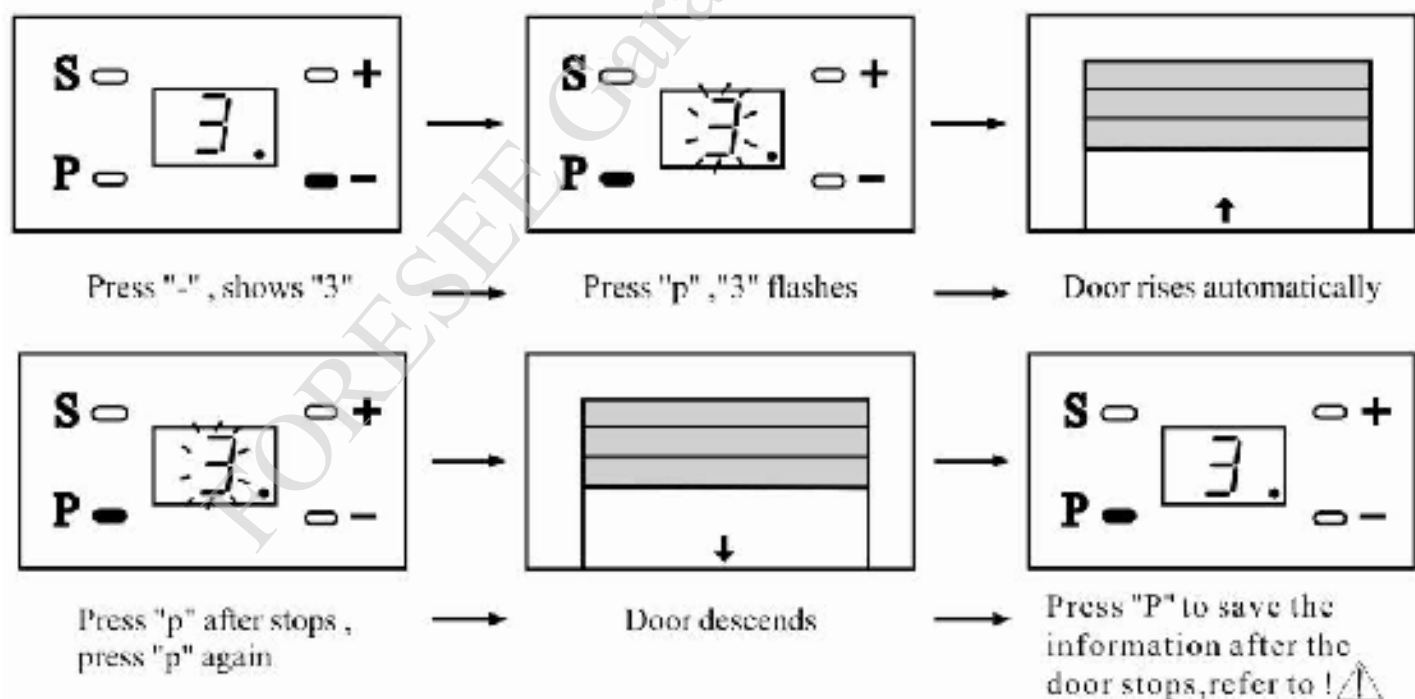

⚠ (After the above basic setting, the user can now carry out the finalizing step to finalize the programming)

F-5 Force Setting

⚠ The unit has been factory set at level 4, resetting by end users is not required.

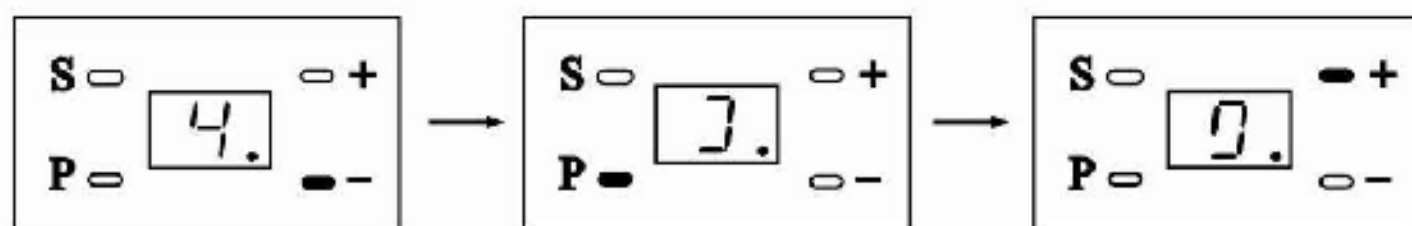

Press "-" to show "4"

Press "p", it shows "3"

Press "+", or Press "-" to select the level



Low

Force level

High



Press "p" to save the setting



(If the force level is set too low, the door moving will be affected when the mechanical structure of the door is not well-balanced.)



After resetting the force level, please run your door for a full cycle before you use it, because the 1st cycle after resetting is for the unit to learn the new force and the force during this cycle is very strong.

F-6 Setting Door Control Button of The Transmitter

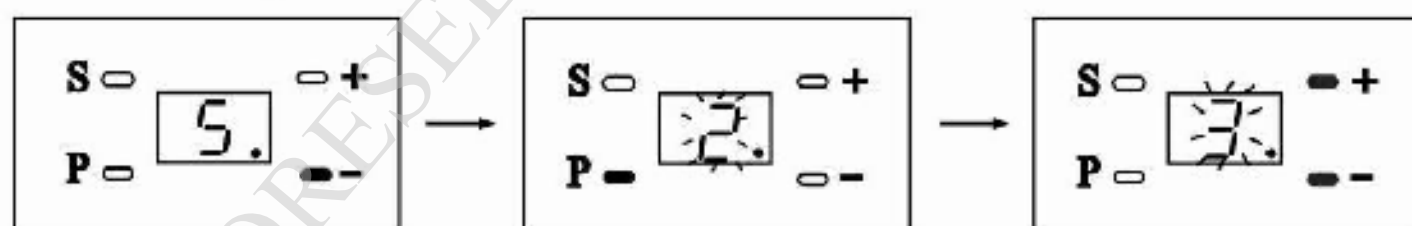

Press "-" to show "5"

Press "p", "2" flashes, it means now the door control channel is set at the second button of the transmitter

Press "+" or "-", to choose a desired button from 1 to 4

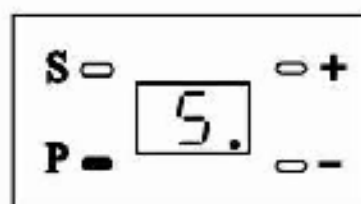

Press key "p" to show "5". save the setting.



The motor has been set at channel 2 at factory to control the door, "0" means no channel is chosen.

F-7 Alarm Setting

(The factory set at "off" position)

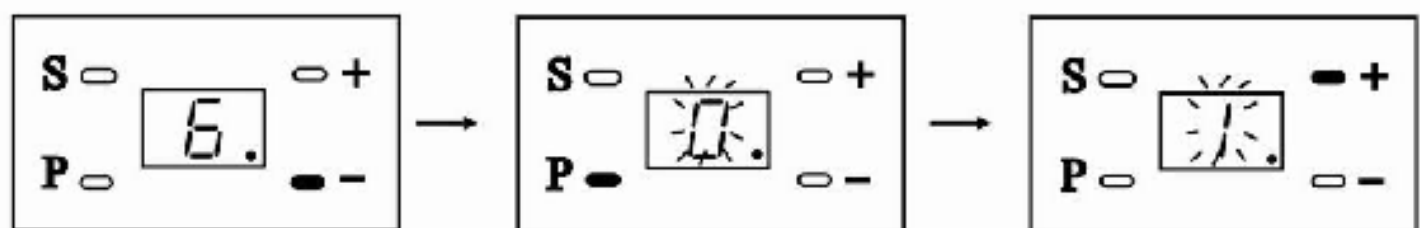

Press "-" to show "6"

Press "p", it shows 0, it means the alarm setting is off

Press "+" ,it shows 1, it means the alarm setting is on.

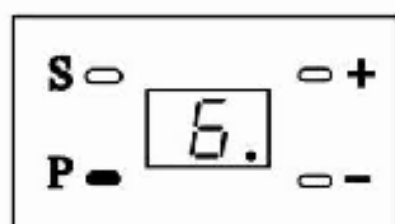

Press "P" again to save the setting

⚠ If the setting is on, the motor will start to beep when the door is open for over 10 minutes, it will beep for 30 seconds every 10 minutes)

⚠ Exit way for the sounding alarm

Press the door Control button to close the door fully.

F-8 Automatic Closing Time Setting

(The factory set at "off" position)

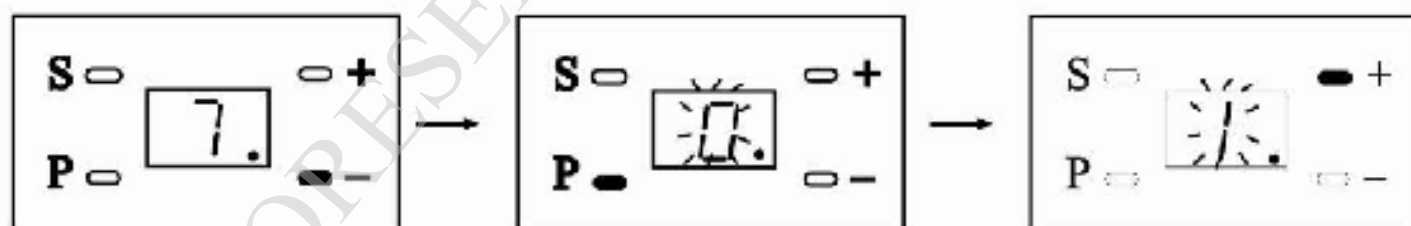

Press "-", shows "7"

Press "P" to show "0", it means the function is off

Press "+" to show "1" to turn on the function, it also means the auto closing time is 30 seconds

Press "+", "-" to choose the time according to the following drawings, 8 means 240 seconds(Maximent), 7 means 210 seconds etc.

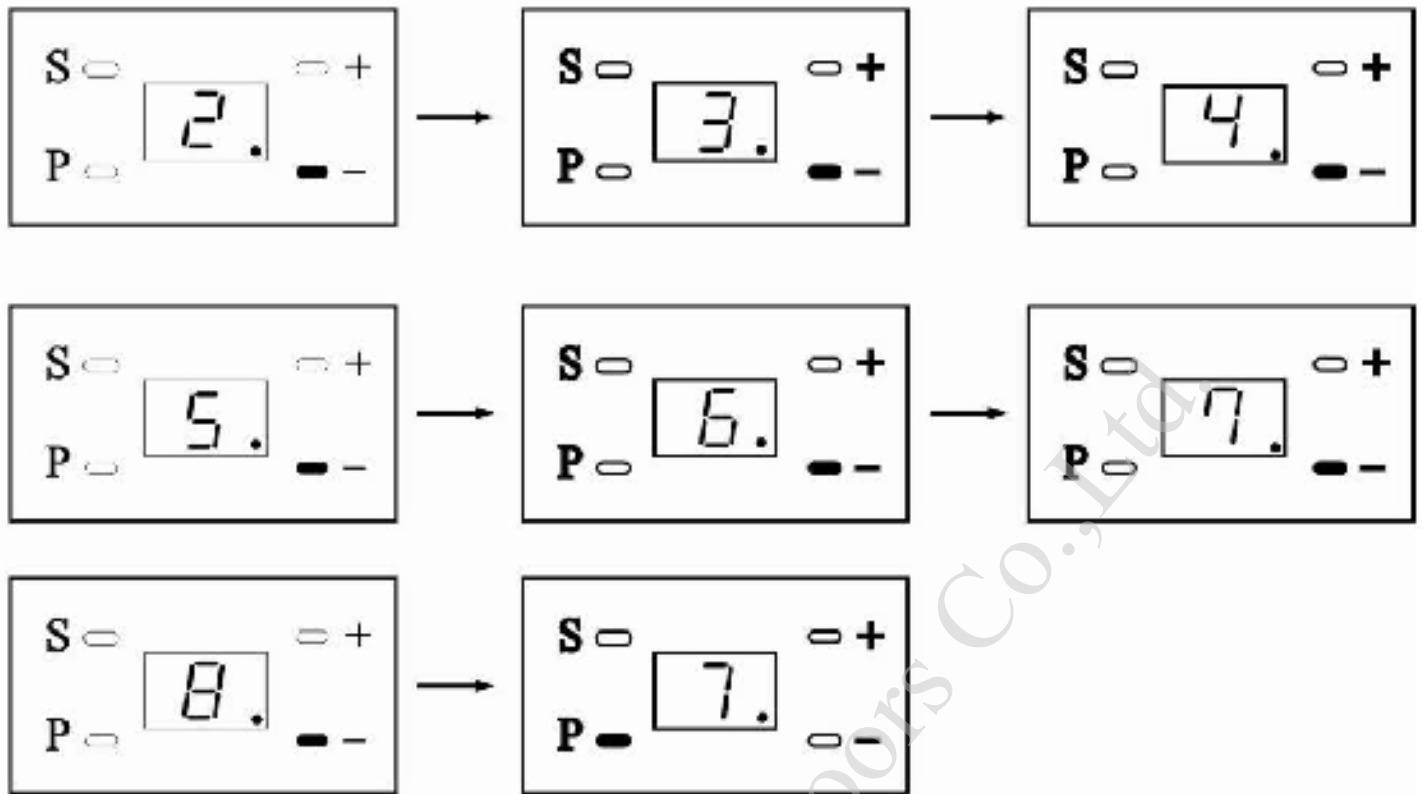

Press key "P" to show "7" and exit the program according to the manual after choosing the time of automatic closing the door.



The motor beeps for 20 seconds before the door starts to close automatically, at the same time the light flashes. When the door starts to close, the motor beeps, the light keeps on but stops flashing. After the door is closed, the motor stops beeping, and the light keeps on for 3 minutes.

F-9 2000 Cycles Alarm Setting

(The factory set at "off" position)

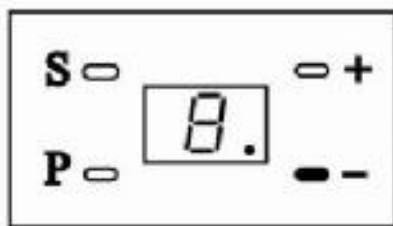

Press "-", shows "8"

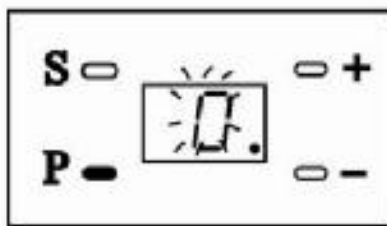

Press "p", it shows 0, it means the function is off

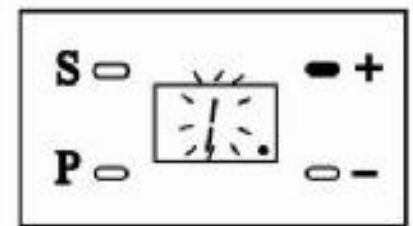

Press "+", it shows 1, it means this function is on.

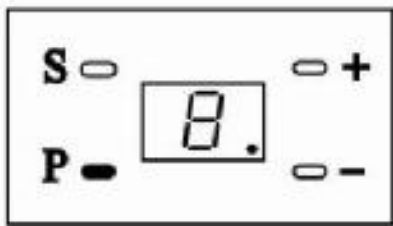

Press "p" to save the setting



After a period of time in use, regularly check to see whether the door is level when opening/closing, whether the spring has enough force to raise the door. Add suitable amount of lubricant to all moving parts regularly.



Exit way for the sounding alarm: turn off the power then switch on again or press the door control button for 5 seconds

F-10 Finalize Programming

⚠ (NB: this finalizing step must be carried out, otherwise the saved information will be lost)

The user has two ways to finalize programming as follows:

Way 1:

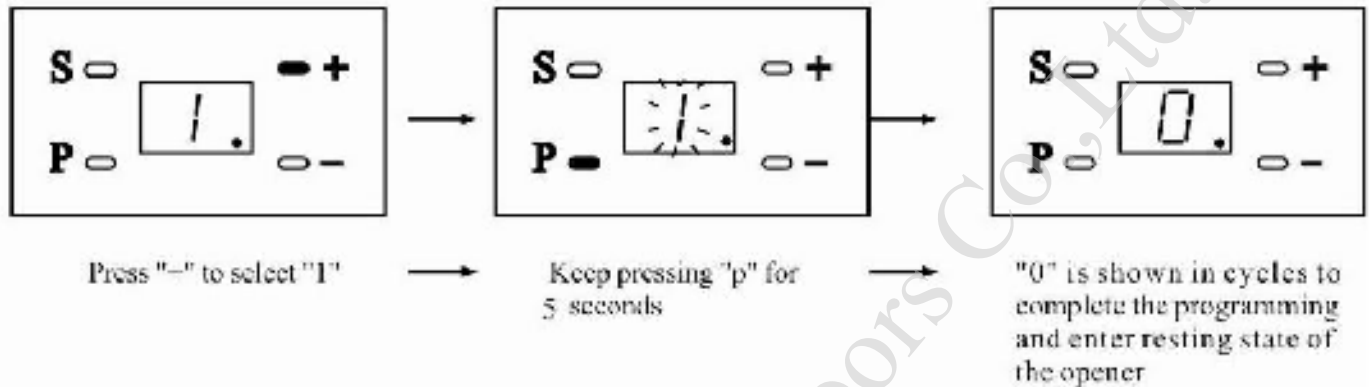

Way 2:

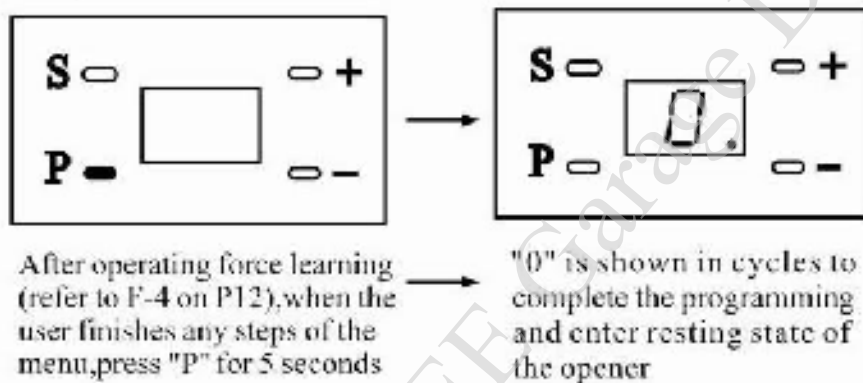

G. Code and Decode

G-1 Code

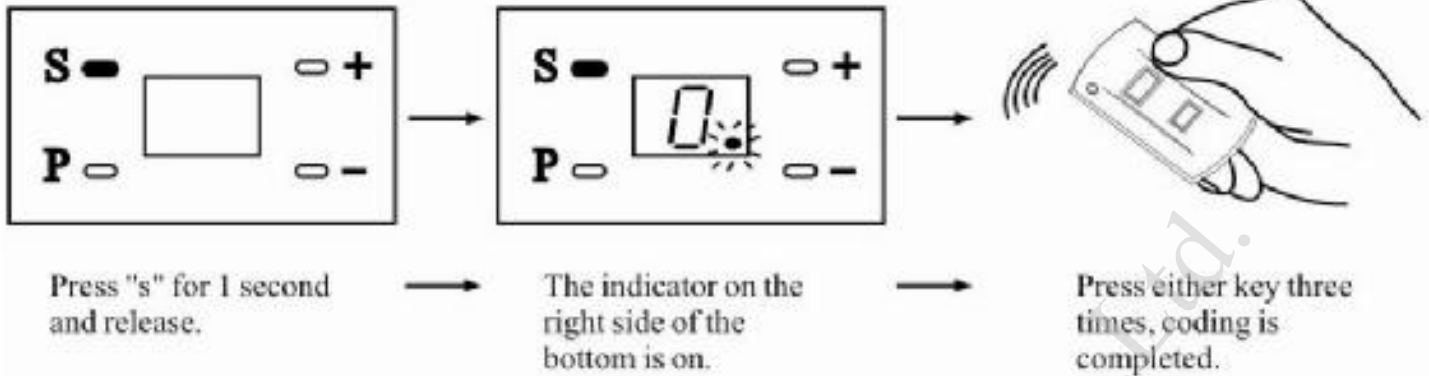

⚠ (By now, the code has been successfully programmed if the transmitters can operate the opener. Other transmitters can be coded as above.)

G-2 Decode

⚠ (For security purpose, if a transmitter has been lost, it must be decoded and the new transmitter encoded as above, so that the lost one can not operate the door any more.)

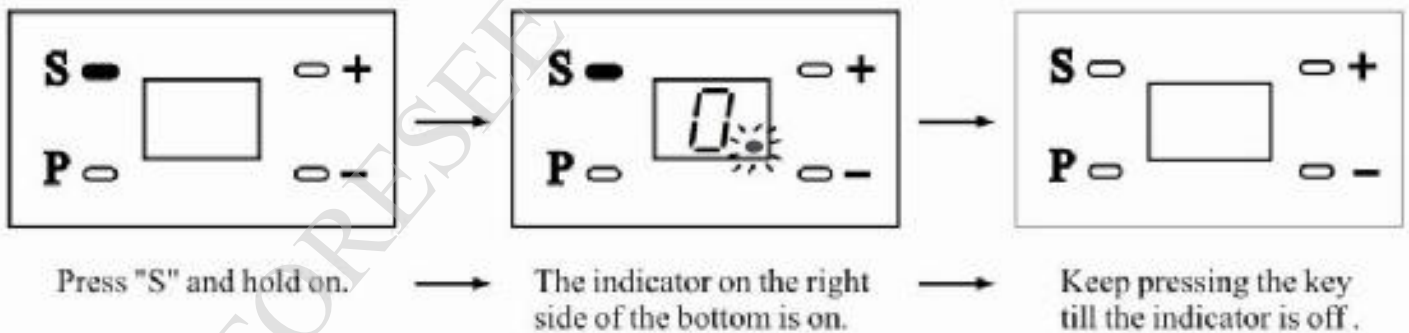

By now, no transmitters can operate the opener unless re-coded.

H. Technical Specification

H-1 Model and Recommended Usage

Model	Voltage(v)	Door size(m ²)	Surrounding difference in temperature(°C)
F-330	180-240	≤ 13	-20~+40

H-2 Guide Rail and Available Sizes

Model	Total length	Travel of the rail	Lifting height
FK-3000	3020mm	2560mm	<2240mm
FK-3300	3320mm	2860mm	<2540mm
FK-3600	3620mm	3160mm	<2840mm

H-3 Specification List

Power	100W
Standby mode	6W
Pulling force	700N
Controller	CPU,24VDC
Controlling method	Impulse inducting
Motor	24V.DC.
Light	25W; E14
Speed of the door	11cm/second
Fuse Model	Power Fuse 1: 2.5A; Light Fuse 2: 2.5A
Speed Induction	Magnetic induction
Transmitter frequency and distance	433 MHz/open space 50m
Drive	Chain
Protecting Method	Keep in dry room

I. End User's Guide

I-1 Notes in use

- F-330 type opener is an environmentally friendly product generally requiring a minimum of maintenance in normal use .
- Examine the drive system to see whether it moves easily when the opener is used for the first time.
- After a period of time in use, regularly check to see whether the door is level, when opening/closing, whether the spring has enough force to raise the door. Regularly lubricate all the moving parts.
- In the event of power failure the operator can search for the program memory. When the power is restored, press the button of the transmitter once, the door will rise.

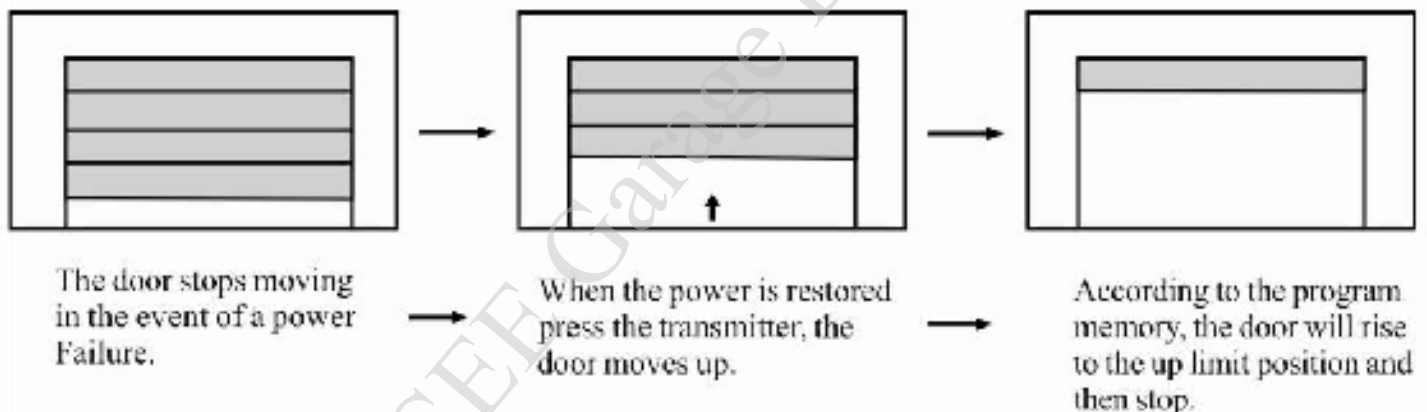

I-2 Normal Operation

- Remote Control** — Opening, closing or stopping can be achieved by the press of a single button on the transmitter.
- Manual operation** — In the event of power failure, opening or closing of the door can be done by hand once the clutch is released. (Please refer to P.8)

I-3 Trouble Shooting

Fault	Causes	Solution
The opener does not work	1.The plug is not securely fitted 2.The fuse is blown	1.Examine by a technician 2.Replace the same type of fuse by a technician
The transmitter can not work the opener	1.No code has been set 2.The battery is out of power	1.Re-code referring to G-1 on P.18 2.Replace with new battery
Remote control distance is too short	The battery is not powerful enough	Replace with a new one of the same model
The chain moves ,but the door does not	The clutch may be disengaged	Engage the clutch referring to C-4 on P.8
In working, a grating sound can be heard	Lack of lubricant between the rail and the clutch after a long period of use	Add suitable amount of lubricant or wax to the position between the rail and the clutch
The chain has come sag and is noisy	Looseness of the chain because of being used for a long time without lubricant between the rail and the clutch	Suitably fasten the bolt on the spring, hold the chain in place and lubricate it

 (NB: To avoid injury, only a professional technician is allowed to deal with the wires and components on the main panel.)

J.Assembly of the Rail in 2 Parts

- ① **Open the rail assembly pack**



- ② **Unfold the rail in the direction of the arrow**

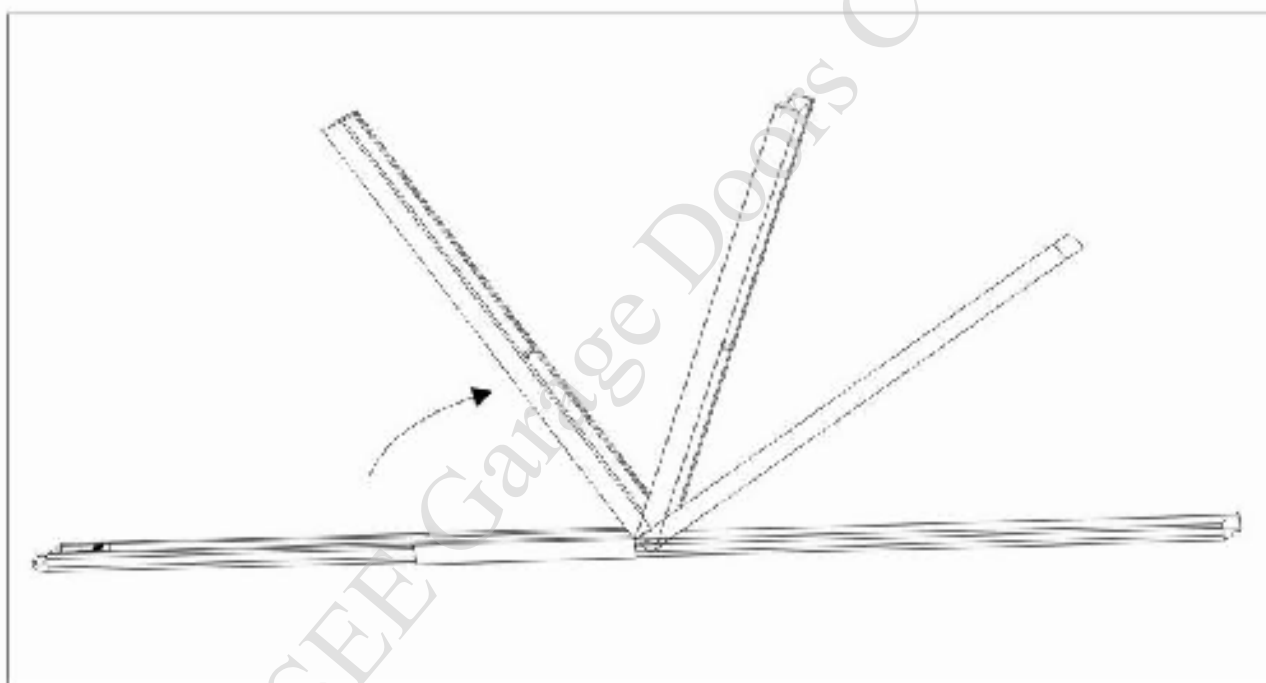

- ③ **Move the connector to the middle of the rail and between the position limits**

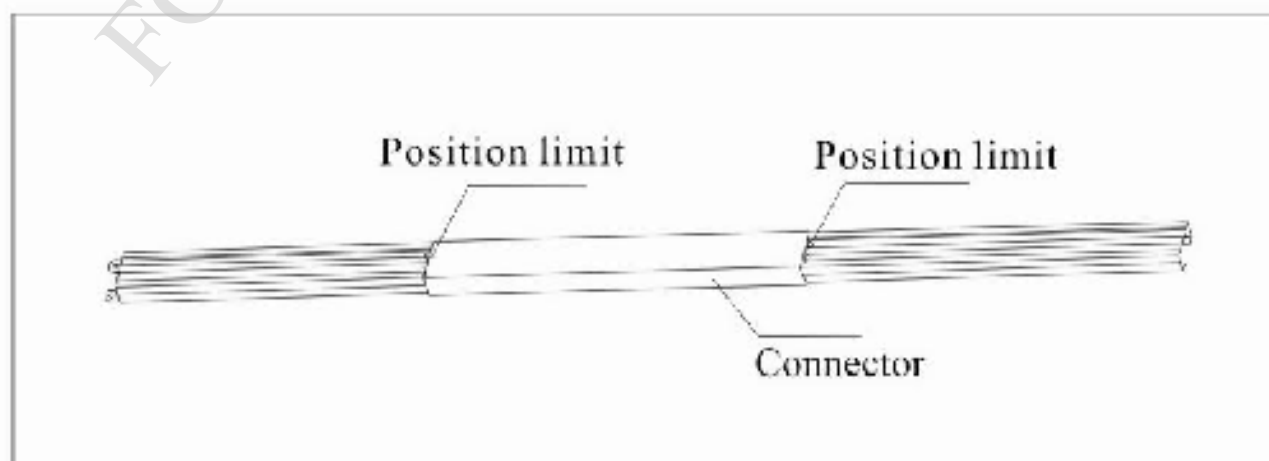

- ④ Tighten the nut with a sleeve of $\phi 10$

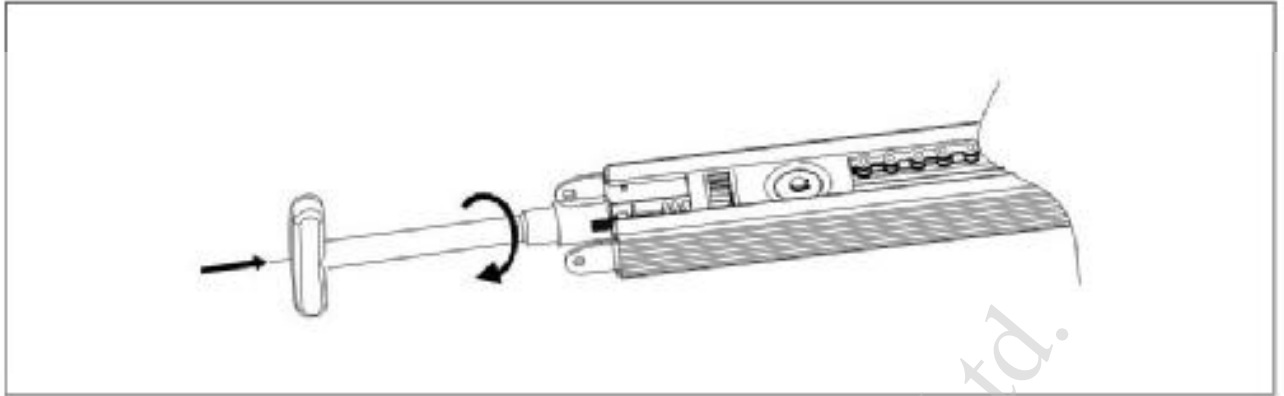

- ⑤ Adjust as the drawing shows

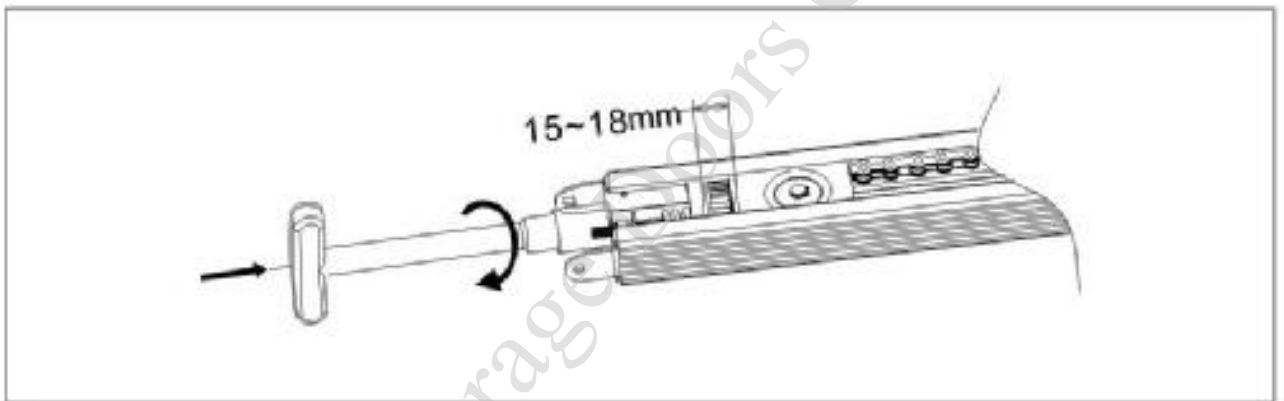

- ⑥ Finished

